

electra

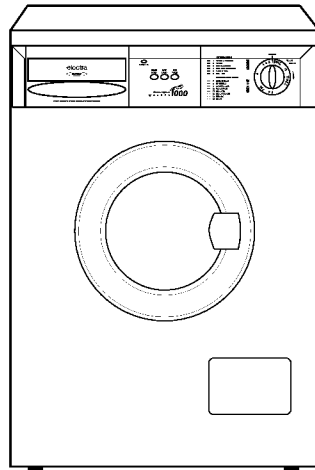

MODEL EAW100W

How to get the best out of your
ELECTRA WASHING MACHINE

It is essential that you read through this
Instruction book carefully before your first wash
and retain it for future reference



Important Safety Information

It is most important that this instruction book should be retained with the appliance for future reference. Should the appliance be sold or transferred to another owner, or should you move house and leave the appliance, always ensure that the book is supplied with the appliance in order that the new owner can get to know the functioning of the appliance and the relevant warnings.

This information has been provided in the interest of safety. You **MUST** read it carefully before installing or using the appliance.

Installation

- This appliance is heavy. Care should be taken when moving it.
- All packing and transit bolts must be removed before use. Serious damage can occur to the product and to property if this is not adhered to. See relevant section in instructions.
- The washing machine must be unplugged when removing the interior transit bolts. Do not plug in the appliance before finishing the removal of the transit bolts and the fixing of the caps in the holes where the security bolts were
- Any plumbing work required to install this appliance should be carried out by a qualified plumber or competent person.
- Any electrical work required to install this appliance should be carried out by a qualified electrician or competent person.
- Care must be taken to ensure that the appliance does not stand on the electrical supply cable.
- If the machine is situated on a carpeted floor, please adjust the feet in order to allow air to circulate freely.
- It is dangerous to alter the specifications or attempt to modify this product in any way.

Child Safety

- This appliance is designed to be operated by adults. Children should not be allowed to tamper with the controls or play with the product.
- Pets and children have been known to climb into washing machines. Please check your drum before use.
- The glass door can become very hot during parts of the washing cycle. Keep children away from the vicinity of the appliance whilst it is in operation.
- Keep all packaging well away for children.
- Keep all detergents in a safe place out of children's reach.

During Use

- Always unplug the appliance and turn off the water after use.
- Do not overload the appliance. See relevant section in instruction book.
- Always look through the glass door to check if water has drained before opening the door.
- The user should always check that they have not left their gas lighter (disposable or otherwise) in their clothing
- Only wash fabrics which are designed to be machine washed. If in doubt, consult the care label on the clothes.
- Before washing, ensure that all pockets are empty and buttons and zips are fastened. Avoid washing frayed or torn articles and treat stains such as paint, ink, rust, and grass before washing. Underwired bras must NOT be machine washed.
- Any objects such as coins, safety pins, nails, screws, stones or any other hard, sharp material can cause extensive damage and must not be placed into the machine.
- Garments which have been in contact with volatile petroleum products should not be machine washed. If volatile cleaning fluids are used, care should be taken to ensure that the fluid is removed from the garment before placing in the machine.
- Wash small items such as socks, laces, washable belts etc in a washing bag or pillow case as it is possible for such items to slip down between the tub and the inner drum.
- Only use the advised quantities of fabric softener. Damage to the fabric can ensue if you over-fill. Refer to the manufacturer's recommendations of quantities.
- As some duvets and eiderdowns should be washed in large commercial machines because of their bulk, please check with the manufacturer of the item before washing in a domestic machine.
- Leave the porthole door slightly ajar between washes to preserve the door seal.
- Under no circumstances should you attempt to repair the machine yourself. Repairs carried out by inexperienced persons may cause injury or serious malfunctioning. Contact the Electricity Company Service Department from whom you purchased the machine .

Contents

Important Safety Information	2	Washing Hints	16-17
Your New Washing Machine	4	Which detergent to use?....	17
Technical Specifications	4	And in which form?	17
Electrical requirements	5	How much detergent and fabric softener?	17
Unpacking Instructions	6	Using a water softening agent	17
Installation Instructions	7	Wash Care Symbols	18
Positioning	7	Washing Programmes	19-20
Water inlet	7	Maintenance and Cleaning	21
Water drainage	8	Descaling	21
Levelling	9	After each wash	21
Special conditions	9	External cleaning	21
In the interest of the environment	9	Cleaning the dispenser drawer	21
Description of the Appliance	10	Cleaning the drawer recess	21
The Control Panel	11	Cleaning the filter	22
Operating sequence	12-15	The dangers of freezing	22
Washing 4,5 kg of white cotton at 90 °C	12	Something Not Working	23-24
Load the laundry	12	How to obtain aftersales service quickly	25
Measure out the detergent	12		
Fabric softener	12		
Select the required programme	13		
Start the machine	13		
At the end of the programme	13		
Washing 2 kg of mixed fabrics at 50 °C	14		
Load the laundry	14		
Measure out the detergent	14		
Fabric conditioner	14		
Select the required option	14		
Select the required programme	15		
Start the machine	15		
At the end of the programme	15		

Guide to use the Instruction Book

The following symbols will be found in the text to guide you throughout the instructions:

 **Safety instructions**

 **Hints and tips**

Your New Washing Machine

Your new electra washing machine, meets all modern needs for effective treatment of laundry with low water, energy and detergent consumption.

- **Automatic cooling of the wash water to 60°C** before draining, with the 90°C programme. This reduces thermal shock to fabrics, helping to prevent any creasing.
- **The special wool programme** with its new delicate wash system treats your woollens with extreme gentleness.
- **The anti-unbalance device** ensures that the washing machine remains stable when spinning.

Ecological hints

To save water and energy and help protect the environment, we recommend that you follow these hints:

- Adjust the quantity of detergent according to the hardness of your water supply, the amount of laundry and the degree of soiling.
- Select an "ECO" programme for normally soiled laundry.
- A programme without prewash is sufficient for normally soiled laundry.

In the interest of the environment

- When the appliance is to be scrapped, cut off the power supply cable and make the door closing device unusable to prevent young children from being trapped inside.
- Help to keep your country tidy - use authorised disposal sites for your old appliance.
- Check with your local Council or Environmental Health Office to see if there are facilities in your area for re-cycling this appliance.
- Materials marked with the symbol  are recyclable.

Technical Specifications

DIMENSIONS	Height Width Depth	85 cm (33.5") 60 cm (23.6") 55 cm (22.7")
POWER SUPPLY VOLTAGE MAX. POWER ABSORBED		230-240 V/50 Hz 2600 W (13A)
WATER PRESSURE	Minimum (cold) Minimum (hot) Maximum	5 N/cm ² (7 psi) 3 N/cm ² (4 psi) 80 N/cm ² (110 psi)
MAXIMUM RECOMMENDED LOAD	Cotton, linen Synthetics Delicate fabrics Wool	4.5 kg (10 lbs) 2 kg (4.5 lbs) 2 kg (4.5 lbs) 1 kg (2.2 lbs)
SPIN SPEED	Maximum	1000 rpm



This appliance complies with the following E.E.C. Directives:

- 73/23 EEC of 19.2.73 (Low Voltage Directive) and subsequent modifications;
- 89/336 EEC of 3.5.89 (Electromagnetic Compatibility Directive) and subsequent modifications.

Electrical Requirements

Any electrical work required to install this appliance should be carried out by a qualified electrician or competent person.

! Before switching on, make sure the electricity supply voltage is the same as that indicated on the appliance rating plate (the rating plate is fixed to the rear of the appliance).

The flexible mains lead is supplied connected to a B.S. 1363 fused plug having a fuse of 13 amp capacity.

Should this plug not fit the socket outlets in your home, it should be cut off and replaced with a suitable plug, following the procedure outlined below-

WARNING

Such a plug cannot be used for any other appliance and should therefore be properly disposed of and not left where children might find it and plug it into a supply socket - with the obvious consequent danger.

N.B. We recommend the use of good quality plugs and wall sockets that can be switched off when the machine is not in use.

IMPORTANT: The wires in the mains lead fitted to this appliance are coloured in accordance with the following code:

GREEN AND YELLOW	- EARTH
BLUE	- NEUTRAL
BROWN	- LIVE

As the colours of the wires in the mains lead of this appliance may not correspond with the coloured markings identifying the terminals in your plug, proceed as follows:

The wire which is coloured green and yellow must be connected to the terminals in the plug which is marked with the letter **E** or by the earth symbol \perp or coloured green or green and yellow.

The wire which is coloured blue must be connected to the terminal which is marked with the letter **N** or coloured black.

The wire which is coloured brown must be connected to the terminal which is marked with the letter **L** or coloured red.

! **WARNING - THIS APPLIANCE MUST BE EARTHED.**

When wiring the plug, ensure that all strands of wire are securely retained in each terminal. Do not forget to tighten the mains lead clamp on the plug. If your electricity supply point has only two pin socket outlets, or if you are in doubt, consult a qualified electrician.

Should the mains lead ever require replacement, it is essential that this operation be carried out by a qualified electrician and should only be replaced with a flexible cord of the same size i.e. 1,5 mm².

After replacement of a fuse in the plug, the fuse cover must be refitted. If the fuse cover is lost, the plug must not be used until a replacement cover is obtained. The colour of the correct replacement fuse cover is that of the coloured insert in the base of the plug or the colour that is embossed in words in the base of the fuse recess or elsewhere on the plug. Always state this colour when ordering a replacement fuse cover.

Only 13 amp replacement fuses which are ASTA approved to B.S. 1362 should be fitted.

Note: Socket outlets are not permitted in bathrooms, neither should any provision be made for connecting moveable electrical appliances. No stationary appliance is to be installed within reach of a person using bath or shower.

In the case of permanent connection it is necessary that you install a double pole switch between the appliance and the electricity supply (mains), with a minimum gap of 3 mm between the switch contacts and of a type suitable for the required load in compliance with the current electrical regulations.

The switch must not break the yellow and green earth cable at any point.

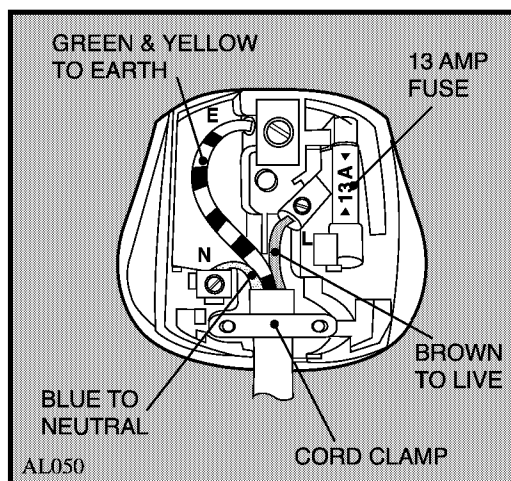

IMPORTANT

Unpacking instructions

All transit bolts and packing must be removed before using the appliance.

 **Note: Your electricity company cannot accept responsibility for damage to your machine if you operate it without removing the transit bolts and packaging.**

You are advised to keep all the transit bolts and packaging for re-use in case the appliance has to be transported again.

- Unscrew and remove the three rear transit bolts (using a 10 mm hexagonal spanner).

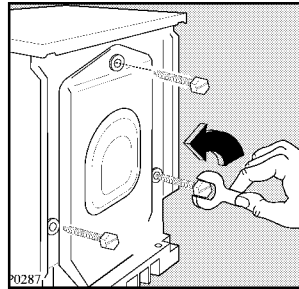

- Lay the machine gently on its back, making sure that the hoses are not squashed.

We suggest a polystyrene angle bracket from the packing is placed on the floor before tilting it back to avoid the hoses being squashed.

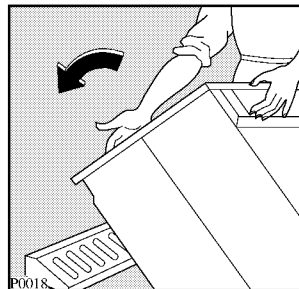

- Carefully remove the polyethylene bags located at the base of the machine by pulling them toward the centre of the machine.

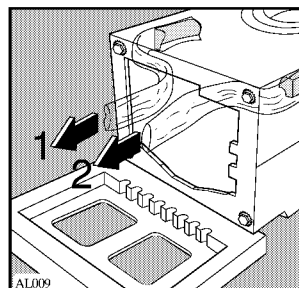

- Place the machine in an upright position and remove the three plastic bolts.

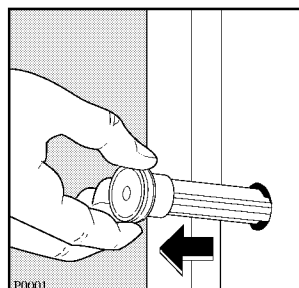

- Plug the 3 holes with the plastic plugs which you can find in the envelope containing the instruction booklet.

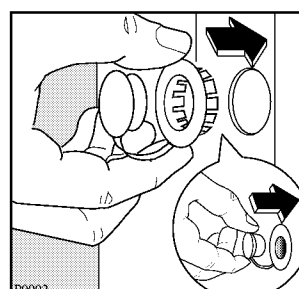

Installation Instructions

 Any plumbing work required to install this appliance should be carried out by a qualified plumber or competent person.

Positioning

Your new washing machine has been designed to be permanently plumbed in to your home's water supply and drainage system. However, if this is not possible, it may be connected to suitable existing taps, with the drain hose discharging into the sink.

The appliance has two inlet hoses, hot and cold, with female 3/4" BSP thread connectors. If this connection is not compatible with the plumbing of the existing installation, a variety of connectors are available from good hardware stores and plumbers merchants to suit most domestic plumbing. Any alterations to your existing plumbing must be carried out by a competent person, or qualified plumber.

Water inlet

The inlets on the back of the appliance are colour coded, blue for cold and red for hot.

Before connecting the hoses, be sure to fit the black washers supplied as per diagram.

If only a cold water supply is available, connect the two hoses to a cold water outlet by means of a 'Y' connection piece.

Installation should comply with local water authority and building regulation requirements.

The appliance must be given a separate cold water supply and not be connected to a mixer tap, a single outlet water heater or a booster pump. A minimum water pressure of 7psi is required for safe operation of the appliance.

If you cannot make the cold water connection direct from the rising mains, you may be able to operate the appliance from your cold water storage system.

There should be a minimum distance of 5.02m (16 1/2ft) between the appliance's inlet and the bottom of the tank.

There will be sufficient pressure for the hot water supply from the hot water cylinder if the height between the appliance's inlet and the bottom of the cold water storage cistern (not between the appliance and the hot water cylinder) is at least 2.74m (9ft).

Set the hoses correctly by loosening the ring nuts. After positioning the inlet hoses, be sure to tighten the ring nuts again to prevent leaks.

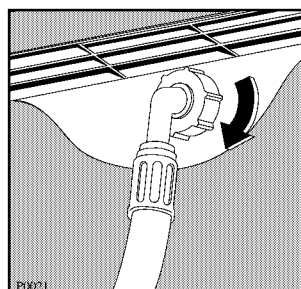
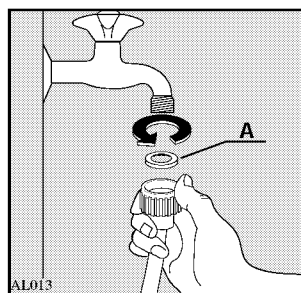
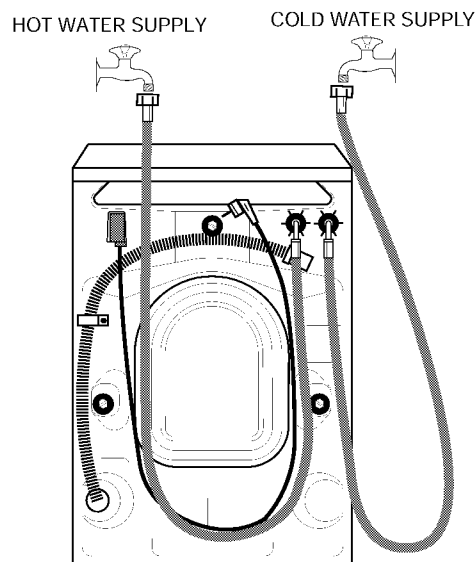

Water drainage

This appliance is designed to be permanently plumbed into your home's water supply and drainage system.

The appliance drain hose should hook (use the plastic "U-piece" supplied) into a standpipe with an internal diameter of approximately 38mm (see diagram) thus ensuring there is an air break between the drain hose and standpipe.

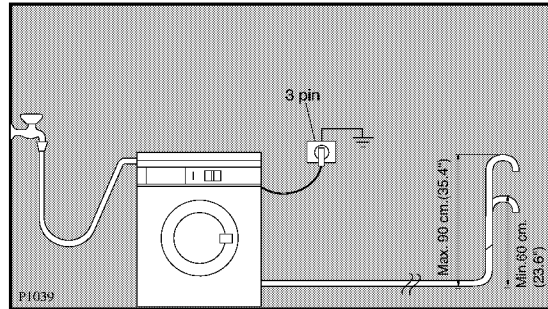

When discharging into a standpipe ensure that the top of the curve in the hose end is no more than 90cm (35.4") and no less than 60cm (23.6") above floor level. The upright standpipe should have a minimum length of 30cm (12") from the bottom of the elbow to the top of the pipe (see diagram).

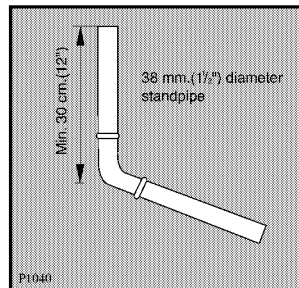

Make sure that it is designed in such a way, that the end of the drain hose cannot be covered with water.

The drain hose may be extended to a maximum of 3 metres. An additional drain hose and joining piece is available from the electricity company from whom you purchased the machine.

The joining piece must have an internal diameter of 18mm.

If you intend the drain hose to empty into a sink, make sure that the sink is empty and the plug hose is not blocked. Use the plastic "U-piece" supplied.

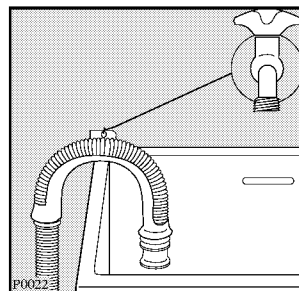

Levelling

Level the washing machine by loosening or tightening the feet. Once in the right position fix the feet by pushing the nuts against the base of the case.

Accurate levelling prevents vibration, noise and displacement of the machine during operation. After levelling the machine, secure the feet by tightening the ring nuts with the aid of a screwdriver.

Some vibration is inevitable, especially if mounted on a wooden floor.

Sprung wooden floors are particularly susceptible to vibration. For advice, consult a builder. If possible, always place the machine on a solid floor.

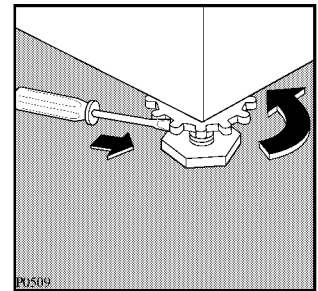
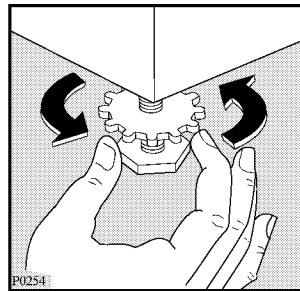

If the machine is situated on a carpeted floor, the feet must be adjusted to allow air to circulate freely under the machine.



Special conditions

If the floor is carpeted with a deep-pile carpet or covered with crumbly or soft material, insert a rigid support base under the feet to prevent noise, vibration or displacement. The base should protrude a few centimetres beyond the edges of the machine.

Warning

-  The machine should NOT be placed on deep pile carpeting.
-  Care must be taken to ensure that the appliance does not stand on the electrical supply cable.

Note

Please ensure that when the appliance is installed it is easily accessible for the engineer in the event of a breakdown.

In the interest of the environment

Washing machines and dishwashers should be connected to the FOUL drainage system, the water will then be taken to a sewage works for treatment before being discharged safely into a river.

It is essential that these appliances are not connected to the surface water drainage system as this water is discharged directly into a river or stream and may cause pollution.

If you require any further advice please contact your local authority drainage department.

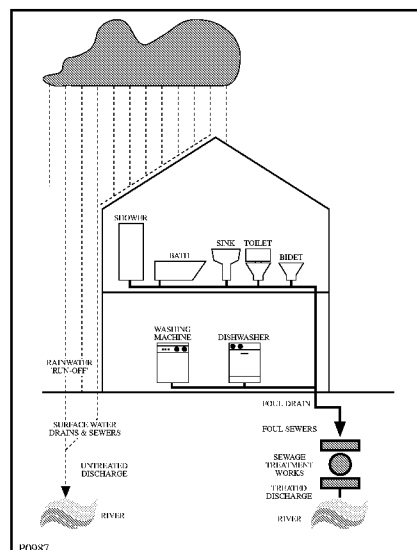

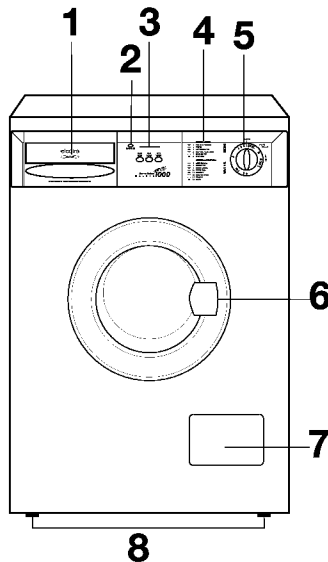

Description of the Appliance

- 1 Detergent dispenser drawer
- 2 "Mains-on" light
- 3 "Options" buttons
- 4 Programme guide
- 5 Program selector dial & ON/OFF switch
- 6 Door opening handle
- 7 Filter
- 8 Adjustable feet



Detergent dispenser drawer

-  Prewash
-  Main Wash
-  Fabric softener

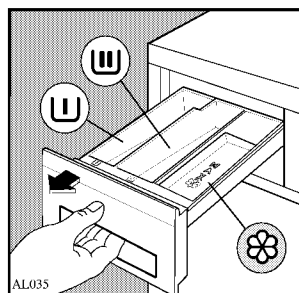

The Control Panel

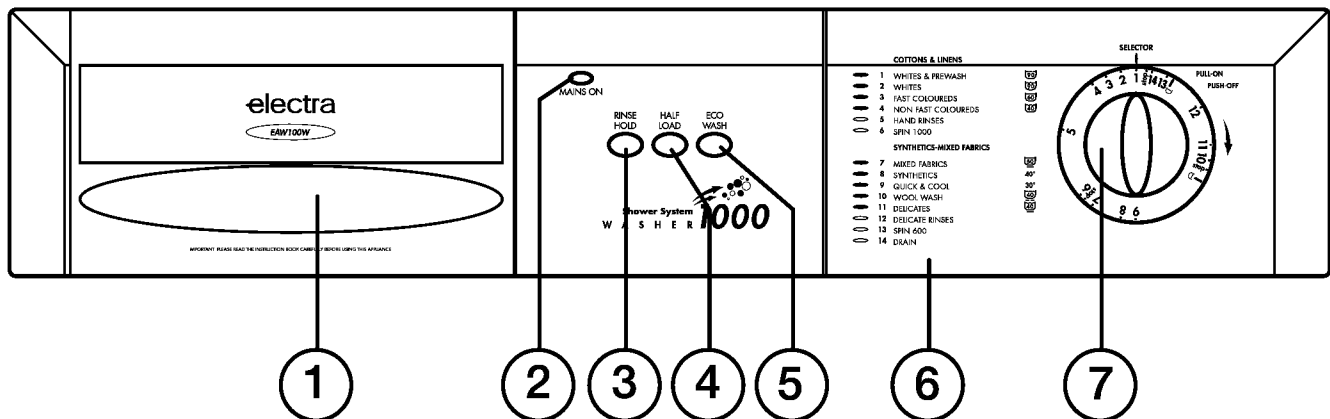

1 Detergent dispenser drawer

2 Mains-on light

This light illuminates when the appliance is operating.

3 RINSE HOLD button

Press this button to make the machine stop with water in the drum after the synthetic or delicate wash cycles. This prevents any creasing which may take place if the clothes are left damp in the drum. When it is convenient for you to empty the machine, simply press this button again so that the machine can proceed to drain and short spin, or turn the dial to the drain programme “14”. If this button is not activated, the washing programmes will end with a short spin.

Do not press this button for woollens: wool items should be gently spun.

4 HALF LOAD button

Available for programmes 1 to 5.

Pressing this button before starting the programme there will be one rinse less which leads to energy and water saving.

5 ECO WASH button

By pushing in this button prior to selecting wash programmes “2” and “3”. You will obtain a reduction of the temperature from 90°C to 60°C and from 60° to 40°C. This will ensure a substantial saving in electricity consumption. It is advisable to use ECO WASH when washing fabrics which are lightly soiled.

6 Programme Guide

7 Programme Selector

To select the required program turn the control clockwise until the marker on the top coincides with the number of the required programme. If you pass the required number **NEVER TURN THE CONTROL ANTICLOCKWISE** just continue clockwise until the required number is reached again.

Operating Sequence

Before your first wash, we recommend that you run a cotton cycle at 60°C, without any laundry in the machine, to remove any manufacturing residue from the drum and tub.

Pour 1/2 a measure of detergent into the dispenser drawer and start the machine.

WASHING 4.5 KG OF WHITE COTTON AT 90°C

Suppose you have 4.5 kg of heavily soiled laundry to wash. It is white cotton and is suitable for high temperature washing

1. Load the laundry

Open the door.

Place the laundry in the drum, one item at a time, shaking out as much as possible. Close the door.

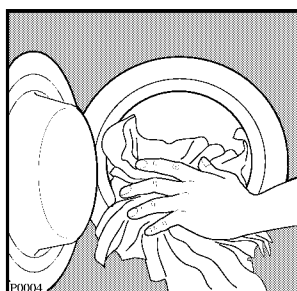

2. Measure out the detergent

Pull out the dispenser drawer until it stops.

Measure out the amount of detergent recommended by the manufacturer in a graduated cup and pour it into the main wash compartment **U**.

If you wish to carry out a prewash(*), pour detergent into the compartment marked **U**

(*). Prewash is available in programme "1".

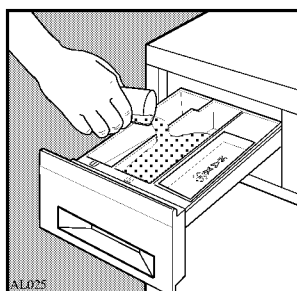

3. Add the fabric softener (if required)

If required, pour fabric softener into the compartment marked **⊗** (the amount used must not exceed the «MAX» mark in the drawer).

Close the drawer gently

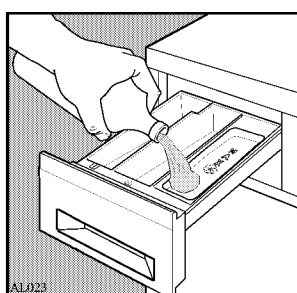

4. Select the required option(S)

Depress HALF LOAD button if required.

5. Select the required programme

Turn the programme selector dial **CLOCKWISE** to the required programme.

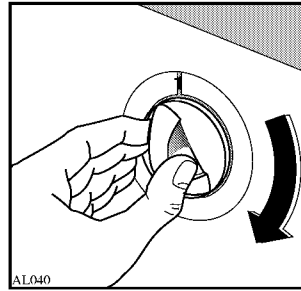

6. Start the machine

Before starting up the machine check that:

- the appliance is plugged in
- the water supply taps are turned on
- the door and the detergent dispenser drawer are closed.

Pull the programme selector dial outwards

The operating pilot light will illuminate and the machine will start operating

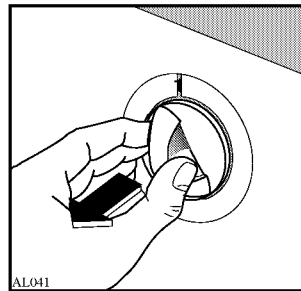

7. At the end of the programme

The machine stops automatically and the mains-on light goes out.

The door is controlled by a safety device which releases 3 minutes after the end of the programme.

Before opening the door ensure there is no water in the drum.

Switch the machine off by pushing in the programme selector dial.

When the programme has finished, you are advised to unplug the appliance and turn off the water taps.

Leave the door open to prevent the formation of mildew and unpleasant smells.

WASHING 2 KG OF MIXED FABRICS AT 50 °C

Suppose you have 2 kg of MIXED FABRICS to wash. They are rather delicate fabrics and should not be washed at a high temperature.

1. Load the laundry

Open the door.

Place the laundry in the drum, one item at a time, shaking out as much as possible. Close the door.

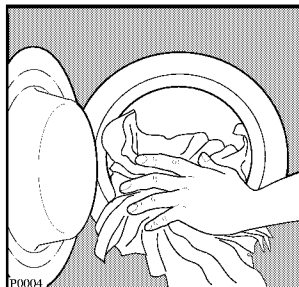

2. Measure out the detergent

Pull out the dispenser drawer until it stops.

Measure out the amount of detergent recommended by the manufacturer in a graduated cup and pour it into the main wash compartment (W).

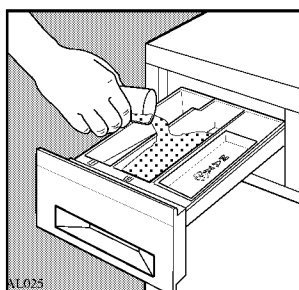

3. Add the fabric softener (if required)

If required, pour fabric softener into the compartment marked  (the amount used must not exceed the «MAX» mark in the drawer).

Close the drawer gently.

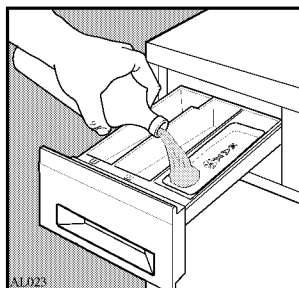

4. Select the required option(S)

Depress RINSE HOLD button, if required

5. Select the required programme

Turn the programme selector dial **CLOCKWISE** to the required programme

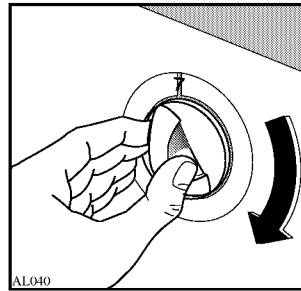

6. Start the machine

Before starting up the machine check that:

- the appliance is plugged in
- the water supply taps are turned on
- the door and the detergent dispenser drawer are closed.

Pull the programme selector dial outwards

The mains-on light will illuminate and the machine will start operating

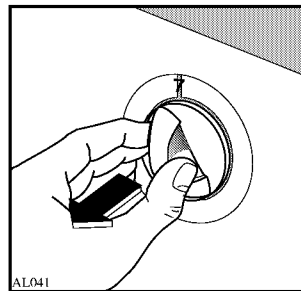

7. At the end of the programme

The machine stops automatically and the mains-on light goes out.

If you have depressed the RINSE HOLD button, the machine will stop with the water left in the tub, to prevent the fabric from creasing. To drain the water release the same button (the clothes will be gently spun) or select programme **“14”**

The door is controlled by a safety device which releases 3 minutes after the end of the programme.

Before opening the door ensure there is no water in the drum.

Switch the machine off by pushing in the programme selector dial.

When the programme has finished, you are advised to unplug the appliance and turn off the water taps

Leave the door open to prevent the formation of mildew and unpleasant smells.

Washing Hints

Do **NOT** overload the machine. Weigh the laundry the first few times you use the appliance.

The average weights of the most common items are listed below as a guide:

1000g = 1 kg

Sheet	700-1000 g
Pillow case	100-200 g
Tablecloth	400-500 g
Serviette	50-100 g
Tea towel	70-120 g
Linen hand towel	100-150 g
Towelling hand towel	150-250 g
Towelling bath towel	700-1000 g
Bath robe	1000-1500 g
Man's shirt	200-300 g
Apron	150-200 g

- Load the laundry loosely alternating large items with small ones.
- Sort the laundry according to the type of fabric, colour-fastness and how dirty it is.
- Avoid washing unhemmed or torn items as they may unravel.
- Before washing, empty all pockets of small objects which may have been left inside (coins, keys, screws etc), as these could damage the drain pump.
- When washing curtains, remove the hooks.
- Close poppers and zips and fasten loose buttons.
- It is essential to wash new coloured items separately when washing for the first time.
- When washing fabrics requiring different wash temperatures together, always select the lowest temperature.
- White items should not be washed with coloured items.
- Very small items (handkerchiefs, ribbons, socks etc) should be washed in a washing bag or a pillow case.
- Use a good quality detergent suitable for automatic washing machines.
- Use the correct quantities of detergent.
- For wool, use gentle detergent only in small quantities.
- Bleach is very corrosive; it should be used with care and kept out of reach of children.

- Some stains such as fruit, wine, grass, rust etc. are difficult to remove and should be treated before washing with specific products, which can be found in most household shops. In some cases it may help to soak the stain before washing with a special pre-soak product or biological detergent.
- Only wool marked «Pure New Wool - washable, preshrunk» can be washed in the machine using the wool programme; other types of wool should be washed by hand or dry cleaned.
- If you have used the machine to wash, rinse or spin only non-colour fast garments, there may be dye left in the sump. To ensure any subsequent wash is not contaminated with the dye, select and carry out a rinse and spin programme, without any garments, to ensure that any dye is removed from the sump.
- Once you have finished using the machine, you are advised to unplug it and turn off the water taps.
- To avoid an excessive and damaging amount of lather when washing net curtains, it is advisable to wash large curtains singularly and take extra care when measuring the detergent.
- Should an excess of lather accidentally occur, switch off the machine, select the spin programme which is preceded by a drain cycle, to remove the lather and then start the wash again.

Note:

Electronic unbalance detection

If spinning starts late or the machine does not spin the electronic unbalance detection device may have cut in because the laundry is not evenly distributed in the drum. The laundry is redistributed by reverse rotation of the drum. This may happen several times before the load is evenly distributed and spinning can resume eventually at a lower speed, if the wash load is still not sufficiently balanced distributed, after 10 minutes, the machine will not spin. In this case, redistribute the load manually and reselect the spin programme.

Which detergent to use?....

To ensure you obtain the best wash results from your appliance, it is important to use the right detergent in your everyday wash, and only detergents recommended for use in front loading automatic machines.

To maintain the appearance of your clothes and household textiles and to make them last longer you should use different types of detergent for different washes, whether for whites, colours or delicates.

And in which form?

Not only are there different types of detergent, but they are also available in different forms. Whether you choose a powder or liquid in traditional or compact form is down to personal choice.

Traditional Powders

Pour the powder directly into the dispenser drawer. Do not sprinkle powder onto clothes in the machine drum.

Traditional Liquids

Liquid can be placed in the main wash compartment of the detergent drawer marked with the symbol , start the machine immediately upon placing the detergent in the dispenser drawer.

Alternatively the detergent is measured into the specially designed dosing device which should be placed on top of the laundry, and at the back of the machine drum.

Compact Powders and Liquids

Compact detergents (or concentrates as they are also known) are available in liquid or powder form, and generally require a smaller dosage. Follow the manufacturer's instructions to ensure the most economical usage. Pour the detergent directly into the dispenser drawer, or alternatively measure the detergent into the specially designed dosing device which should be placed on top of the laundry, and at the back of the machine drum.

Fabric Conditioners

These are ideal for improving "softness", and also reduce static cling on synthetics and make ironing easier.

The liquid fabric softener should be poured into the compartment marked with the symbol  .

Follow the manufacturer's dosage instructions and never exceed the MAX level.

How much detergent and fabric softener?

The amount to be used depends on:

the load:

if the detergent manufacturer does not make any specification for small loads, use a third less for half loads, and for very small loads only use half of the amount of washing powder recommended for a full load.

the degree of soiling of the washing:

for only lightly soiled washing use less washing powder. Follow the instructions of the detergent manufacturer.

the water hardness:

















the harder the water, the higher the dosage!

Using a water softening agent

In hard water areas, the use of a water softening agent can reduce the amount of detergent necessary. See manufacturers recommendations.

Wash Care Symbols

Wash care labels inside garments recommend how to launder your clothes with the best results. The care labelling code is in line with care labelling used in the rest of Europe. The symbols used make it easy to select the correct programme on your washing machine.

WASHING SYMBOL	WASH ACTION	FABRIC
	Normal (Maximum)	White Cotton or Linen without Special Finishes
	Normal (Maximum)	Cotton, Linen or Viscose without Special Finishes Colour fast at 60°C.
	Reduced (Medium)	Nylon, Polyester/Cotton, Viscose with Special Finishes, Cotton/Acrylic Mix.
	Normal (Maximum)	Cotton, Linen or Viscose Colour fast at 40°C but not 60°C.
	Reduced (Medium)	Acrylics, Acetate, Triacetate, Wool mixes, Polyester/wool blends.
	Much Reduced (Minimum)	Wool, wool mixtures, Silks
	Hand wash only	Do not machine wash
BLEACHING		
	Chlorine bleach may be used	
IRONING		
	Hot iron	Cotton, Linen, Viscose
	Warm iron	Polyester mixtures, Wool
	Cool iron	Acrylic, Nylon, Polyester
DRY CLEANING		
	May be dry cleaned. Other letters and/or a bar beneath the circle will indicate the required process to the dry cleaner.	
TUMBLE DRYING		
	May be tumble dried	
	with high heat setting	
	with low heat setting	
	A cross through any symbol means «DO NOT»	







Important Notes

For best results, always use the dispenser drawer for dispensing detergents and liquid additives. Once the dispenser has been filled, close it by pushing it in gently. This is particularly important if you are using fabric conditioner to avoid the conditioner entering the machine prematurely.

When using liquid detergent and a prewash programme, place the detergent into the correct compartment in the dispenser drawer, after the prewash has finished.

Washing Programmes

Programmes for cotton and linen

Wash programme	Degree of soil and type of laundry	Programme dial position	Description	Possible options	Max. load
 Whites+Prewash	White cotton, for example heavy soiled garments, sheets, household linen, underwear, towels.	1	Prewash at 40 °C Wash at 90°C 4 rinses Long spin at 1000 rpm	HALF LOAD	4.5 kg
 Whites	White cotton, for example normally soiled garments, sheets, household linen, underwear, towels.	2	Wash at 90°C 4 rinses Long spin at 1000 rpm	HALF LOAD	4.5 kg
 Whites+ ECO WASH	White cotton, for example lightly soiled garments, sheets, household linen, underwear, towels.	2+ECO (*)	Wash at 60°C 4 rinses Long spin at 1000 rpm	HALF LOAD	4.5 kg
 Fast coloureds	Fast coloured cotton or linen fabric, shirts, underwear, towels. (normally soiled)	3	Wash at 60°C 4 rinses Long spin at 1000 rpm	HALF LOAD	4.5 kg
 Fast coloureds+ ECO WASH	Fast coloured cotton or linen fabric, shirts, underwear, towels. (lightly soiled)	3+ECO	Wash at 40°C 4 rinses Long spin at 1000 rpm	HALF LOAD	4.5 kg
 Non fast coloureds	Non fast coloured cotton or linen fabrics, shirts, blouses, underwear.	4	Wash at 40°C 4 rinses Long spin at 1000 rpm	HALF LOAD	4.5 kg
Hand Rinses	Separate rinse cycle for hand washed garments.	5	4 rinses Long spin at 1000 rpm	HALF LOAD	4.5 kg
Spin 1000 rpm	Separate spin for cotton and linen items	6	Long spin at 1000 rpm		4.5 kg

(*) This 60°C programme is the reference programme for the Energy label according to EEC Directive 92/75.



Water 67 litres
 Energy 1.2 kWh
 Time 125 minutes

Water filling:

Programmes 30°-40°C **cold** water filling
 Programmes 50°-60°C **hot and cold** water filling
 Programmes 90°C **hot** water filling

Washing Programmes

Programmes for synthetics, delicates and wool

Wash programme	Degree of soil and type of laundry	Programme dial position	Description	Possible options	Max. load
 Mixed fabrics	Synthetic or mixed fabrics, underwear, coloured garments, non-shrink shirts, blouses.	7	Prewash Wash at 50°C 3 rinses Short spin at 600 rpm (*)	RINSE HOLD	2 kg
40 Synthetics	Synthetic or mixed fabrics, underwear, coloured garments, non-shrink shirts, blouses.	8	Wash at 40°C 3 rinses Short spin at 600 rpm (*)	RINSE HOLD	2 kg
30 Quick & Cool	Lightly soiled synthetic or delicate items	9	Wash at 30°C 3 rinses Short spin at 600 rpm (*)	RINSE HOLD	2 kg
 Wool wash	Specially tested programme for wool garments	10	Wash at 40°C 3 rinses Short spin at 600 rpm		1 kg
 Delicates	Delicate fabrics, for example curtains.	11	Wash at 40°C 3 rinses Short spin at 600 rpm (*)	RINSE HOLD	2 kg
Delicate Rinses	Separate rinse cycle for hand washed garments	12	3 rinses (with fabric softener if required) Short spin at 600 rpm (*)	RINSE HOLD	2 kg
Spin 600	Separate spin for synthetics and delicates	13	Draining of water and short spin at 600 rpm.		2 kg
Drain	For emptying out the last rinse water in programmes with Rinse Hold option	14	Draining of water		-

(*) If the **RINSE HOLD** button has not been depressed.

Maintenance and Cleaning

 Before any maintenance or cleaning is carried out you must **DISCONNECT** the appliance from the electricity supply

Descaling

The water we normally use contains lime. It is a good idea to periodically run a high temperature wash with detergent or use a descaler in the machine. Do this separately from any laundry washing, and according to the manufacturer's instructions. This will help to prevent the formation of lime deposits.

After each wash

Leave the door open for a while. This helps to prevent mould and stagnant smells forming inside the appliance. Keeping the door open after a wash will also help to preserve the door seal.

External cleaning

Clean the exterior cabinet of the appliance with soap and water only, and then dry thoroughly.

Clean the control panel using a damp cloth only.

 Do not use abrasives

Cleaning the dispenser drawer

From time to time the washing powder and additive dispenser drawer should be cleaned.

Remove the drawer by pressing the catch downwards and by pulling it out. Flush it out under a tap, to remove any traces of accumulated powder.

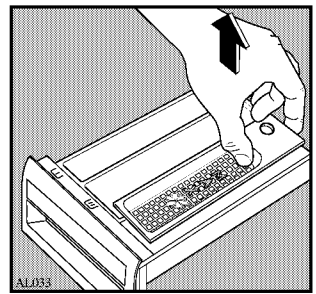
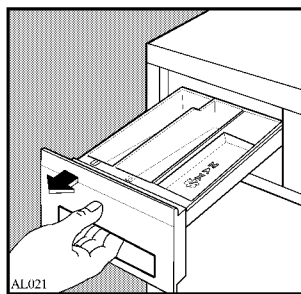

Cleaning the drawer recess

Having removed the drawer, use a small brush to clean the recess, ensuring that all washing powder residue is removed from the upper and lower part of the recess.

Replace the drawer and run the rinse programme for a few minutes without any clothes in the drum.

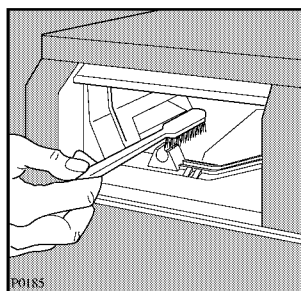

Cleaning the filter

The water drain filter

A clean filter is important for the correct functioning of the machine, and should therefore be cleaned after every washing programme.

Open the filter door and place a container underneath to catch any spillage. If the filter is blocked and the machine is unable to drain you will need to drain the water manually from the machine at this stage. To do this, unhook the drain hose from the standpipe or sink and hold the end of the hose over a bowl on the floor. The water should drain by gravity into the bowl. When the bowl is full, hook the hose back up and empty the bowl. Repeat the procedure until water stops flowing out.

Unscrew and remove the filter.

Clean carefully under a fast running tap.

Replace the filter turning now clockwise and tighten it.

Warning

When the appliance is in use and depending on the programme selected there can be hot water in the filter. Never remove the filter during a wash cycle, always wait until the appliance has finished the cycle, and is empty. When replacing the filter, ensure it is securely retightened so as to stop leaks and young children being able to remove it.

The water inlet filters

If your water is very hard or contains traces of lime deposit, the water inlet filters may become clogged.

It is therefore a good idea to clean it from time to time.

Turn off the water taps. Unscrew the water inlet hoses. Remove and clean the filters using a hard bristle brush. Replace the filters and tighten up the inlet hoses.

The dangers of freezing

If the machine is exposed to temperatures below 0°C, certain precautions should be taken.

- Turn off the water taps.
- Unscrew the inlet hoses.
- Unhook the drain hose from the rear support and position the end of this hose and that of the inlet hose in a bowl. Run the draining programme.
- Disconnect the appliance.
- Screw the inlet hoses and reposition the drain hose.
- When you intend to start the machine up again, make sure that the room temperature is above 0°C.

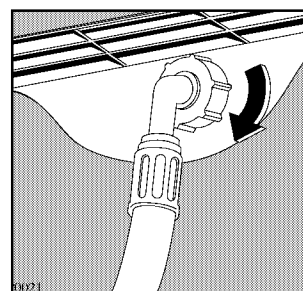
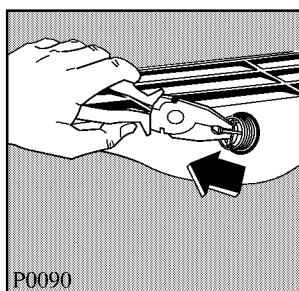
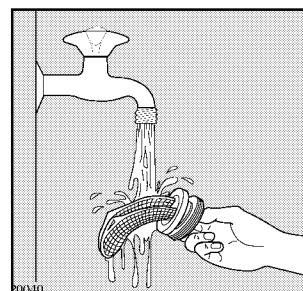
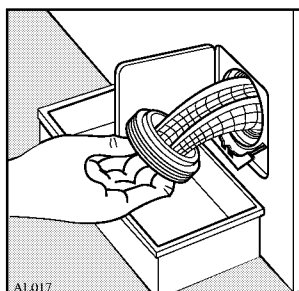
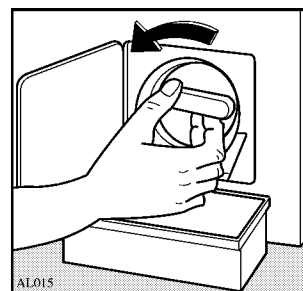
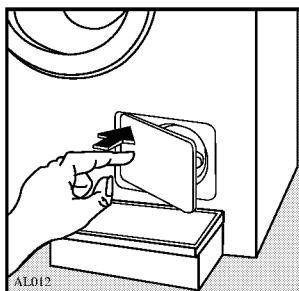

Something Not Working

Certain problems are due to lack of simple maintenance or oversights, which can be solved easily without calling out an engineer. Please carry out the checks listed below- it could save a lot of trouble, time and expense.

Important: If you call out an engineer to a fault if listed below or to repair a fault caused by incorrect use or installation a charge will be made even if the appliance is in guarantee.

Symptom	Possible causes
The machine does not start	<ul style="list-style-type: none"> ■ The door has not been closed. ■ The plug is not properly inserted in the power socket. ■ There is no current at the socket ■ The main fuse has blown. ■ The selector dial is not correctly positioned and pulled out ■ No water is entering the machine (see: the machine does not fill)
The machine does not fill	<ul style="list-style-type: none"> ■ Ensure the water taps are open and the water supply has not been disconnected ■ The filter in the inlet hoses are blocked. ■ The inlet hoses may be squashed or kinked. ■ The water pressure is too low
The machine fills then empties immediately	<ul style="list-style-type: none"> ■ The end of the drain hose is too low. ■ The end of the drain hose is submerged in water. ■ There is no vent in the end of the drain hose.
The machine does not empty and/or does not spin	<ul style="list-style-type: none"> ■ The drain hose may be squashed or kinked ■ The RINSE HOLD option has been selected. ■ The drain filter may be blocked ■ The drain hose extension is not correct. Follow the instructions for connecting to the waste. ■ The drainage system pipes are blocked.
There is water on the floor	<ul style="list-style-type: none"> ■ Too much detergent or unsuitable detergent has been used (creates too much foam). ■ Check whether there are any leaks from one of the inlet hose fittings. It is not always easy to see this as the water runs down the hose; check to see if it is damp. ■ The drain hose may be damaged or not securely positioned. ■ The detergent dispenser drawer or recess is clogged. ■ The drainage system pipes are blocked.
Unsatisfactory washing results	<ul style="list-style-type: none"> ■ Too little detergent or unsuitable detergent has been used. An insufficient amount of detergent leaves the laundry looking grey and causes lime scale to form. ■ Stubborn stains have not been treated prior to washing ■ The correct temperature to suit the wash programme has not been selected. ■ Too much laundry has been placed in the drum.
The machine vibrates or is noisy	<ul style="list-style-type: none"> ■ The internal packing has not been removed. ■ The machine is in contact with the wall or furniture. ■ The machine is not level. ■ The washing load is badly distributed in the drum. ■ Maybe there is very little laundry in the drum. ■ The machine is overloaded

Symptom	Possible causes
The door will not open	<ul style="list-style-type: none"> ■ The programme is still running. ■ The door lock has not yet released ■ The water level in the drum is too high or the machine is heating.
Spinning starts late or the machine does not spin	<ul style="list-style-type: none"> ■ The electronic unbalance detection device has cut in because the laundry is not evenly distributed in the drum. The laundry is redistributed by reverse rotation of the drum. This may happen several times before the load is evenly distributed and spinning can resume eventually at a lower speed, if the wash load is still not sufficiently balanced distributed, after 10 minutes, the machine will not spin. In this case, redistribute the load manually and reselect the spin programme.
The machine makes an unusual noise	<ul style="list-style-type: none"> ■ The noise produced when spinning may differ from your previous washing machine, which is due to the modern drive system. This new motor ensures a softer start and more even distribution of the laundry in the drum when spinning, as well as increased stability of the machine.
No water is visible in the drum	<ul style="list-style-type: none"> ■ Machines based on modern technology operate very economically using very little water without affecting performance.

GUARANTEE

This guarantee is offered to you as an extra benefit and does not affect your legal rights.

Electra products are carefully designed, manufactured, tested and inspected and in consequence we undertake to replace or repair any part found to be defective in material or workmanship, within one year of delivery to the original purchaser, free of charge.

The Company does not accept liability for defects arising from neglect, misuse, or accident.

There are certain conditions which may invalidate this guarantee:

- a) It is dependent upon the washing machine being correctly installed and used in accordance with the Company's instructions under normal domestic conditions within the United Kingdom or the Republic of Ireland.
- b) Service under the guarantee must be carried out by an Electricity Company Service Representative.
- c) The guarantee may be invalidated by unauthorised repair or modification of the washing machine.

Your receipt is proof of the date of purchase and will be required before service under guarantee is provided.

MODEL NO.
EAW100W



PART NO.
35.292.566/0